

1. INSPECTION

This instrument has been thoroughly tested at the factory before shipment. However, when you receive it, visually inspect it for damage and check the accessories.

1.1 Model number and specification check

Check to see if the model number and specification on the nameplate attached to the front cover of the isolator are as ordered by you.

1.2 The contents of the instruction manual

This instruction manual provides instructions on how to mount, wire externally and maintain the output isolator.

2. GENERAL

This instrument receives 1 to 5V DC signal and converts it into an isolated 4 to 20mA or 10 to 50mA DC signal.

Accessories:	Mounting block	2
	Tag number label	1
	Mounting screw M4	2

3. MOUNTING METHOD

JUXTA signal conditioners can be mounted on racks, walls or DIN rails.

3.1 Rack mounting

Use a panel (FRK-16) and install it on an angle as shown in Fig.1. This is a convenient method for high density mounting of the isolators on a 19-inch rack panel. (See Fig. 7.)

3.2 Wall mounting

Use the panel (FRK-16) to mount the isolator as shown in Fig. 2 or directly mount it on to a wall mount bracket. (See Figs. 7 and 8 for mounting dimensions.)

3.3 DIN rail mounting

Insert a DIN rail into the upper section of the DIN rail groove on the rear of the isolator and fix the rail with the slide lock at the lower part of the isolator as shown in Figs. 3 and 4.

3.4 Angle mounting

If the isolator is mounted without using the panel (FRK-16), refer to Fig. 5 for mounting dimensions.

3.5 Mounting block installation and removal

Insert a mounting block into the isolator groove as shown in Fig. 6 and slide it until it is fixed with the stopper. To remove it, lift up the mounting block stopper with a screwdriver.

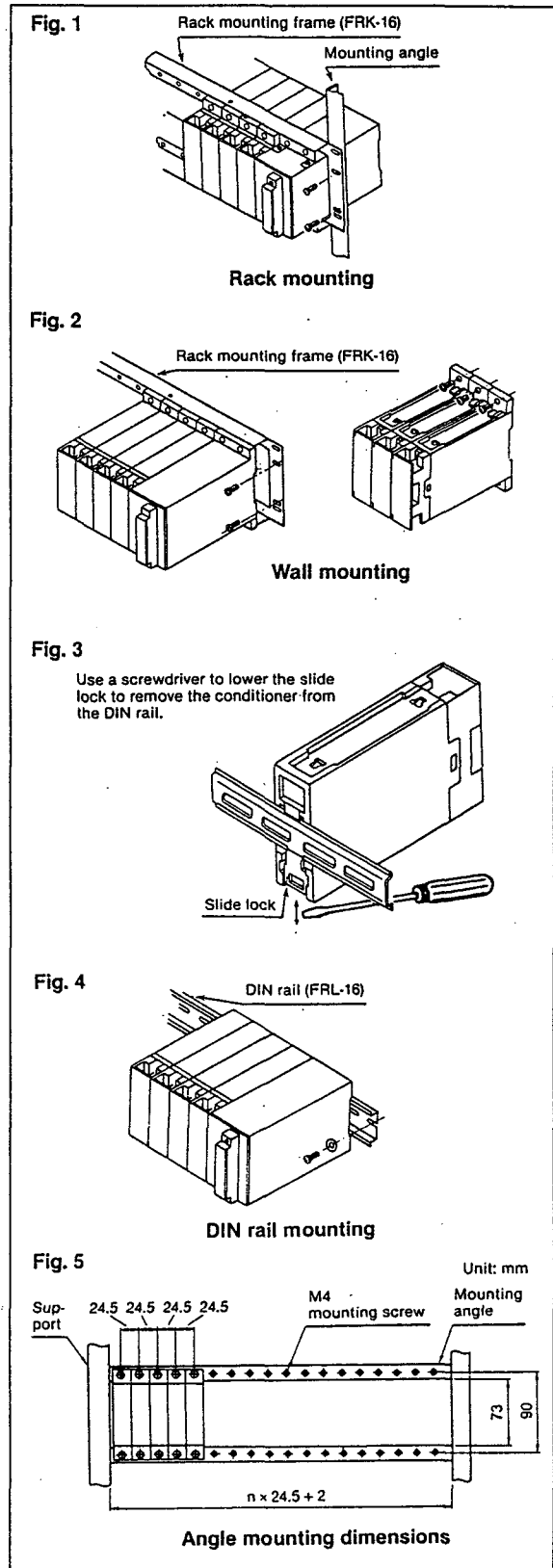

4. EXTERNAL WIRING

Wires can be connected to terminals by opening the isolator terminal cover. It is recommended that very flexible twisted wires be used for wiring, and good and reliable round crimp-on terminals (JIS C2805) be used.

4.1 Signal cable

Nominal cross-sectional area of conductor:
0.5 to 0.75 mm²

Example of suitable cable:
Twisted vinyl cord (VSF) (JIS C 3306)

4.2 Power cable

Nominal cross-sectional area of conductor:
1.25 to 2.00 mm²

Example of suitable cable:
Twisted 600V vinyl cord (IV) (JIS C 3307)

4.3 Wiring

- ① See Fig. 9 for the terminal arrangement.
- ② Connect input signal cable to isolator terminals 2(+) and 3(-).
- ③ Connect isolator output signal cable to its terminals 4(+) and 5(-).
- ④ Connect 24V DC power cable to isolator terminals 6(+) and 7(-). (See Fig. 10.)

5. ITEMS TO BE CHECKED BEFORE TURNING THE POWER SWITCH ON

- ① Make sure that 24V DC power cable of the isolator is connected with the correct polarities (+) and (-).
- ② Confirm that the external wiring to the terminal board is correct.
- ③ Check that the mounting conditions; ambient temperature, humidity, dust and vibration are suitable (e.g. within specification). Confirm the above items before turning on the power supply. The isolator needs 5 minutes warmup to meet its specified accuracy levels.

6. MAINTENANCE

(Caution)

Carry out the following calibration after warming up the isolator for more than 5 minutes.

6.1 Calibration equipment

- Voltage/current generator (Yokogawa model 2553 or equivalent) 1
- Voltmeter (Yokogawa model 2502A or equivalent) 1
- Precision resistor (250Ω ±0.01%, 1W) 1

6.2 Calibration

- ① Connect each unit of equipment as shown in Fig. 11.

② Input/output characteristic check

Use a voltage/current generator to apply input signals equivalent to 0, 25, 50, 75 and 100% of input span to the isolator. Check that corresponding isolator outputs are 0, 25, 50, 75 and 100% of output span respectively and are within an accuracy rating range.

*If an output signal is out of tolerance, adjust it with the span adjustment and zero adjustment VRs on the front panel of the instrument.

Fig. 6

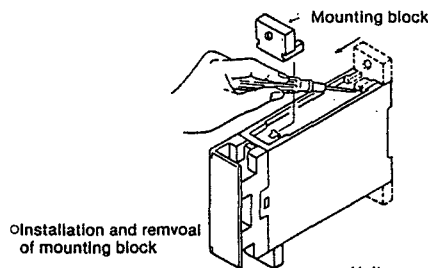

Fig. 7

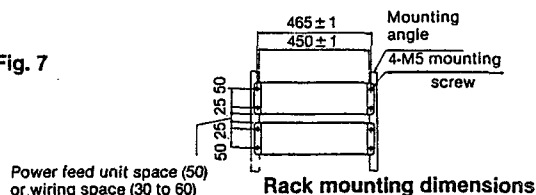

Fig. 8

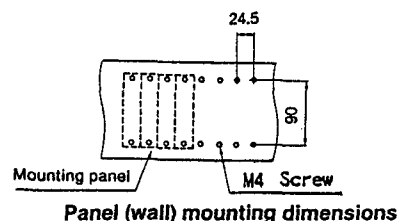

Fig. 9

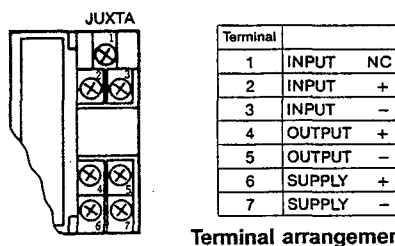

Fig. 10

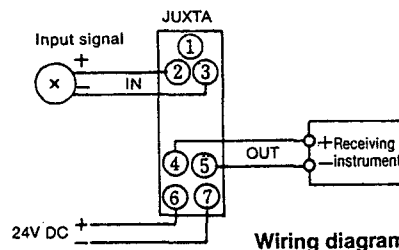
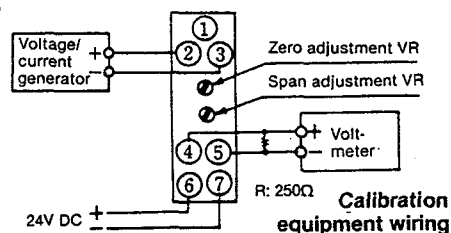

Fig. 11



Subject to change without notice for grade up quality and performance.